

# ALFA 2.1 STAND FOR FLAT ROOFS

## INSTALLATION GUIDE

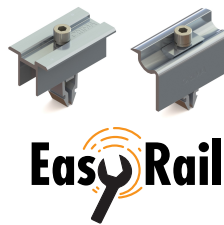
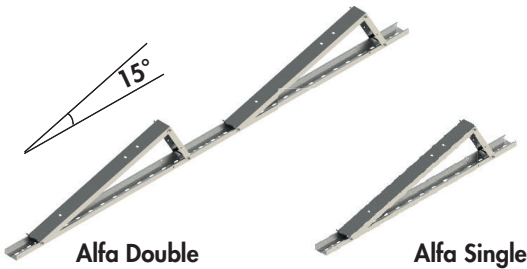
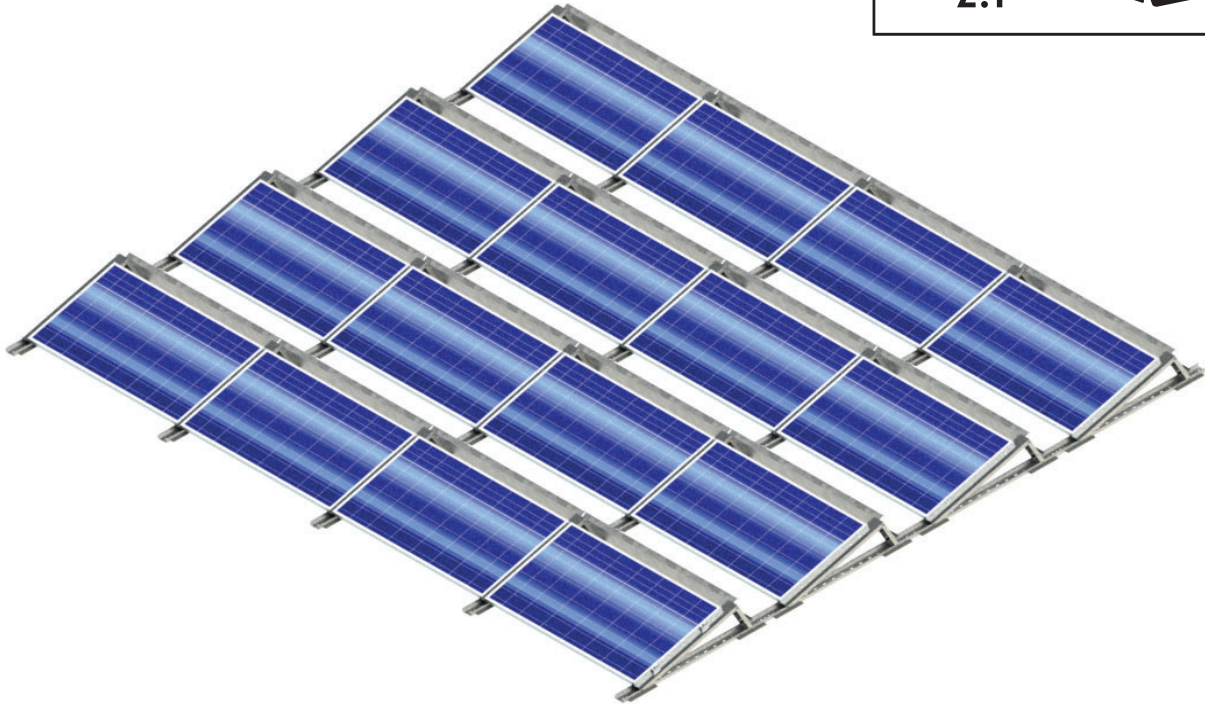

### MEASUREMENTS

Panel size:

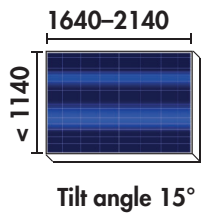

Alfa stands are delivered pre-assembled.

Project specific wind load calculation and ballast layout.

Maximum concrete block sizes for the ballasting of rear wind deflector.

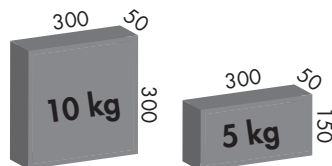

### TOOLS

Hex key 6

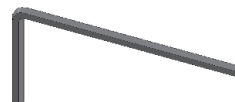

Socket wrenches



Screwdriver



Torque wrench



1. ALFA STANDS

**ALFA DOUBLE 38770**

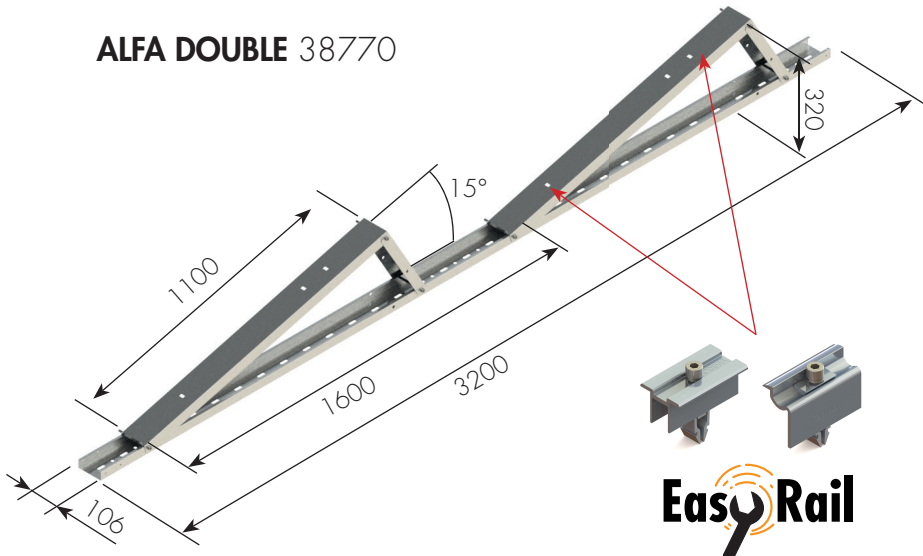

**ALFA SINGLE 38780**

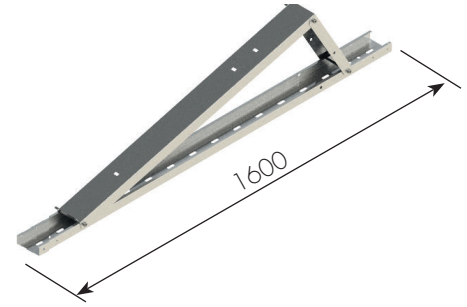

**Protective Rubber Mat for Bitumen 36580**

**Protective Rubber Mat for PVC 38160**

- 4 pc./Alfa, 2 pc./Alfa Single

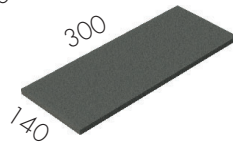

**Joint piece 38790**

**Taprite M6x16 40124**

8 x 

AV 10

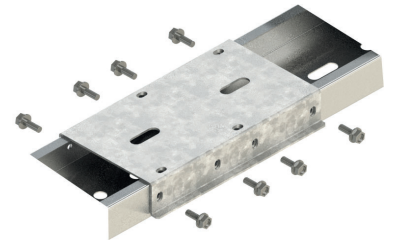

**Field spacing**

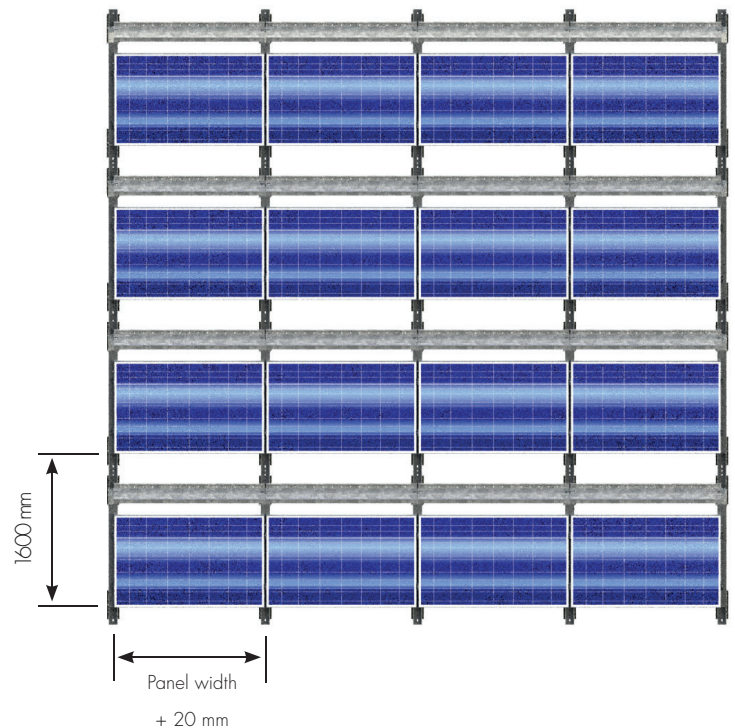
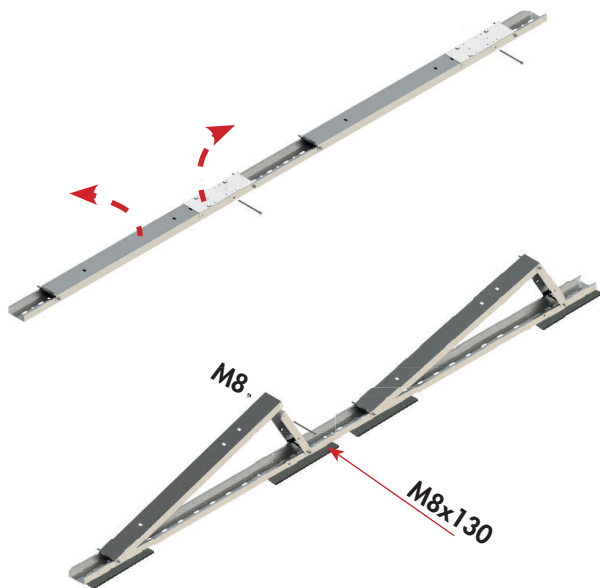

## 2. BALLAST AND WIND DEFLECTOR

### Placing of ballast blocks on rear wind deflector (38800-X)

Fastening: 2 x  M6x16 Taptite/Wind deflector.

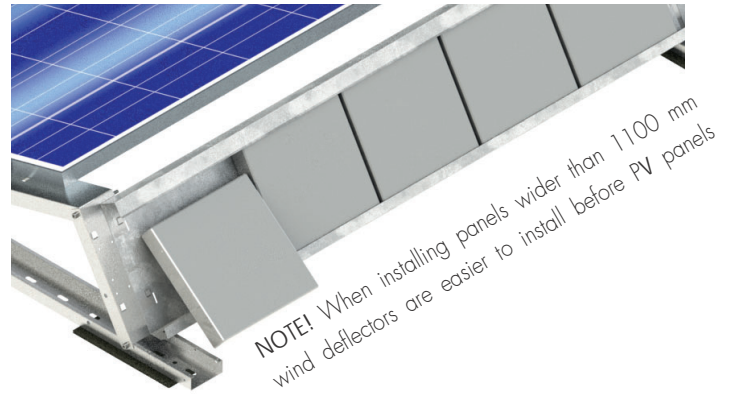
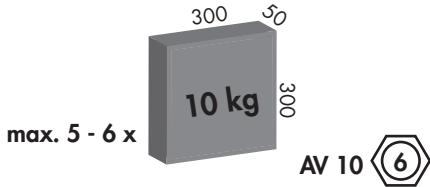

### Rear wind Deflector models

38800-*	-1	-2	-3	-4	-5	-6	-7	-8	-9	-10
Panel range [mm]	1640-1690	1690-1740	1740-1790	1790-1840	1840-1890	1890-1940	1940-1990	1990-2040	2040-2090	2090-2140
Ballast blocks	5	5	5	5	5	6	6	6	6	6

### Secondary placing of ballast blocks

Other ballast block sizes may be placed on the bottom beam. For example:

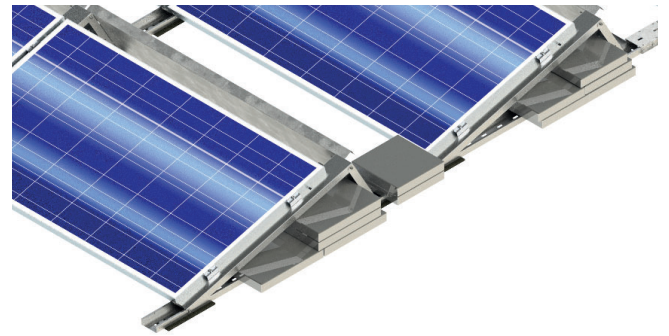
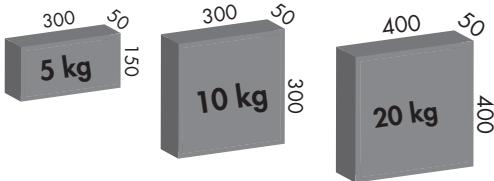

## 3. INSTALLING THE PANELS

### Easy Rail Universal middle clamp set 10 pc.

38820, black 3882033

### Easy Rail Universal End Clamp Set 8 pc.

38810, black 3881033

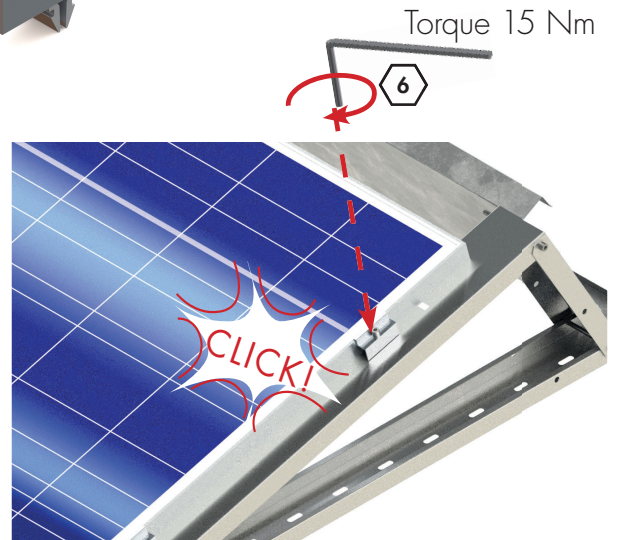
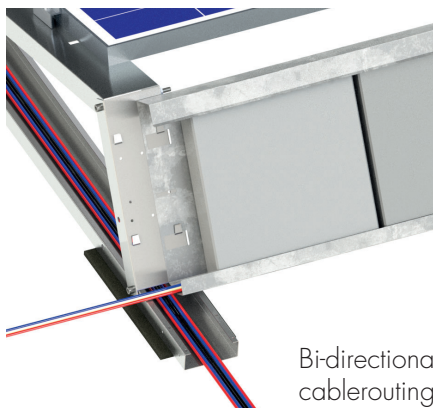
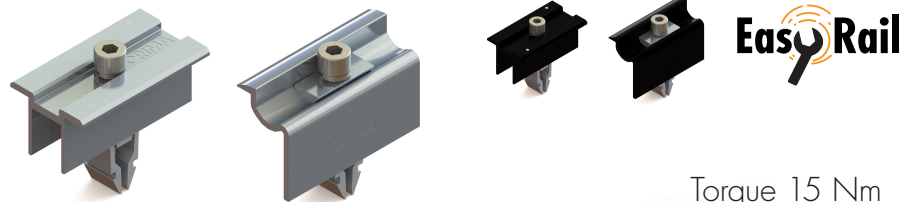



#### 4. ACCESSORIES

##### ALFA ALPINE 38760

Additional middle support for snowy regions.

+ 2x Protective Rubber Mat

(Bitumen 36580/PVC 38160)

+ 2x End Clamp

Maximum panel width 1070 mm



##### Solar UP - Universal Platform



Non penetrating fixing system for flat and low slope SBS/bitumen roofs.

UP Plate 36300

UP SBS Mat 36390

UP Bolt Set, 10 pc. 36310

Installation guide: Solar UP - Universal Platform

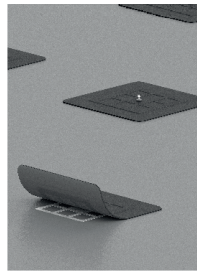

##### UP plate placing

- First 1300mm.
- Next 1600mm.

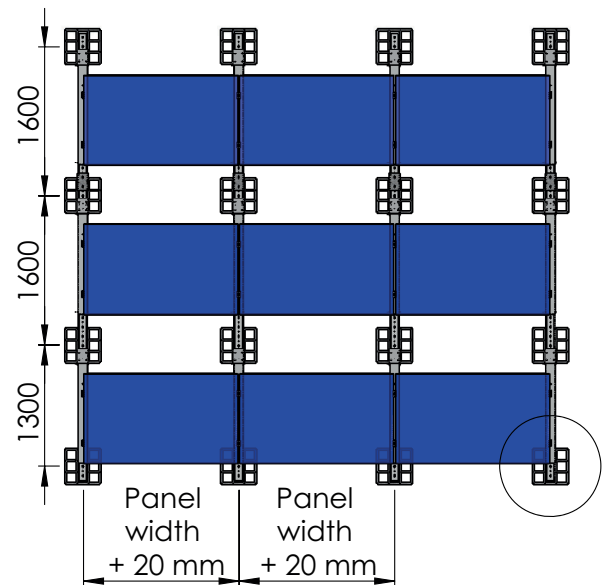
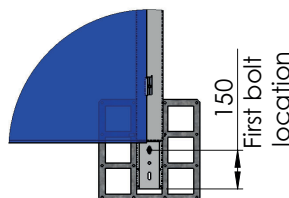

##### Cable holder 50 pc. 36550

Cable holder attached to the panel frame. Can hold up to 4 cables. One holder per one panel.

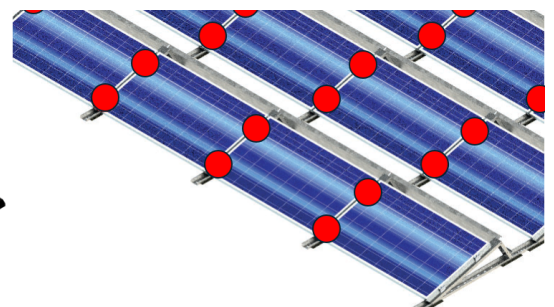

**Middle clamps** have integrated grounding pins for ensuring the electric continuity.

